



INTRODUCES

MGS6 EV





S M A R T  
S E R E N I T Y

WHERE  
TECHNOLOGY THINKS,  
COMFORT CALMS

Introducing the all-electric MGS6 EV.  
A spacious mid-size family SUV that's  
been intelligently equipped and elegantly  
finished to ensure every detail serves  
your comfort.

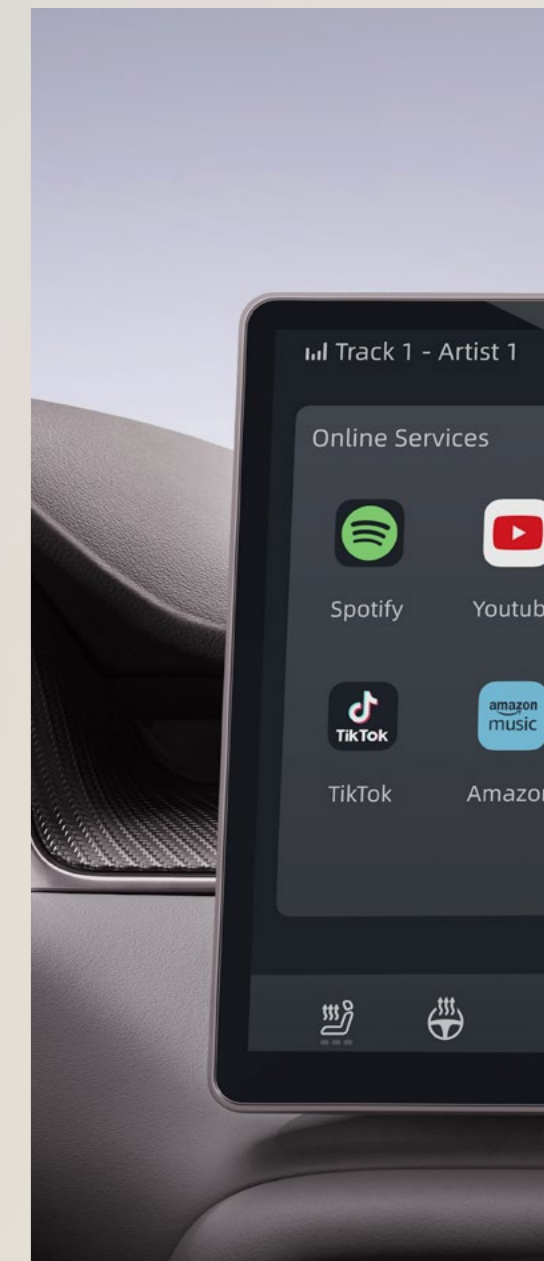



AMBIENCE

CONSIDERED  
COMFORT

It could be bleak outside,  
yet pure bliss within.

- HEATED & VENTILATED SEATING
- PANORAMIC ROOF
- 11 SPEAKER AUDIO SYSTEM





#### SUMPTUOUS SEATING

Settle into heated and ventilated leather style seats that soothe each passenger under the expansive panoramic roof above. Heated seats extend to the outer rear seats for unrivalled comfort.

#### THOUGHTFUL SPACE

Inside, 1,910 litres\* of thoughtfully adaptable space creates room to breathe. Ambient lighting creates calm, while an eleven speaker audio system fills the cabin and suede-effect trim softens every surface.

The rear boot has an impressive 674 litres of storage and the front boot (known as the frunk), adds a further 124 litres^ of convenient space - perfect for everyday essentials like shopping bags or charging cables neatly in reach.

#### PANORAMIC ESCAPE

Let natural daylight or the serenity of the night sky flood through the sweeping 1.96m<sup>2</sup> panoramic roof, complete with an electric blind for the perfect balance.

\*With rear seats folded  
^Rear wheel drive variants



SUBLIME SOUND

Surround yourself with sound as the 11 speaker audio system immerses the cabin.

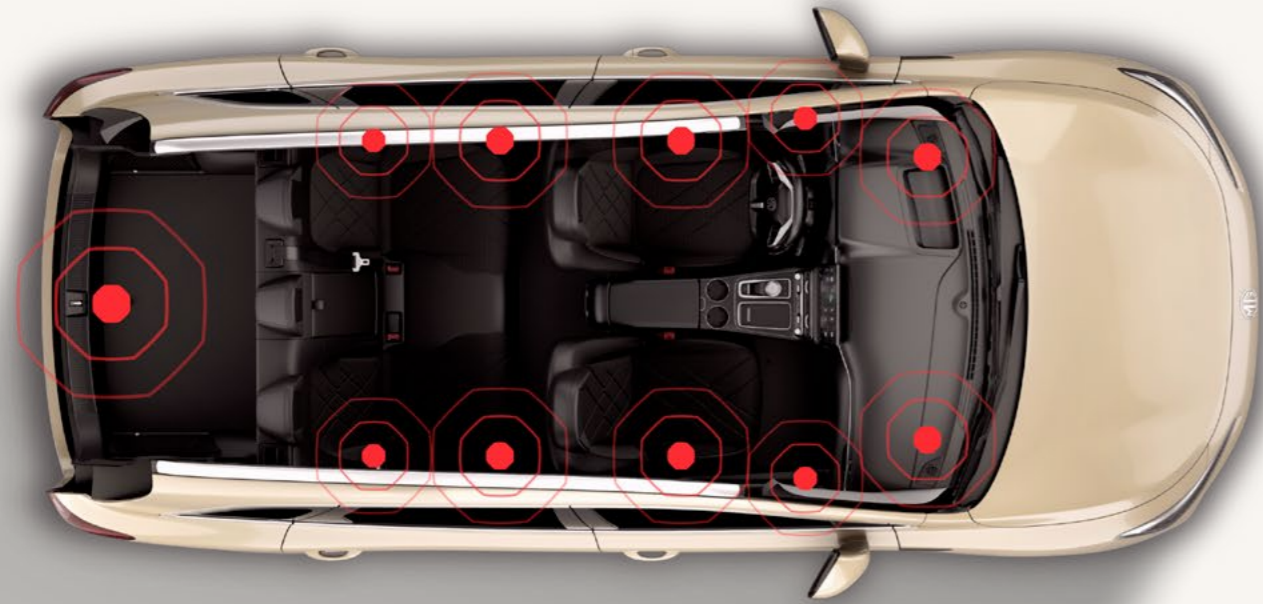

SOFT TOUCHES

Leather style and suede effect material soften every surface.



DRIVE CONTROL

SMART  
POWER

Beneath the serenity lies  
intelligent engineering at work.

- 530KM (WLTP) EV COMBINED RANGE\*
- 38 MIN FAST CHARGE TIME^
- ALL WHEEL DRIVE OPTION



\*Range figures provided are calculated under test conditions. These figures are for comparative purposes only and may not reflect real-life driving results. Actual range may vary depending on various factors such as weather conditions, driving styles, vehicle load, and accessories fitted post-registration.  
^10-80% charging time applies to a 150kW Ultra-Fast charger under standardised test conditions. Charging times in real world conditions will vary dependent on a number of factors, including but not limited to the age of battery, charging conditions, temperature and the existing charge of the battery, charger used and duration of charge. Charging times will be increased when using chargers of a lower capacity. Availability of 150kW-capable chargers may be limited depending on your location.



77kWh Battery



5.1sec, 0-100km/h\*



7 year warranty  
/ 150,000km

\*Luxury Dual Motor

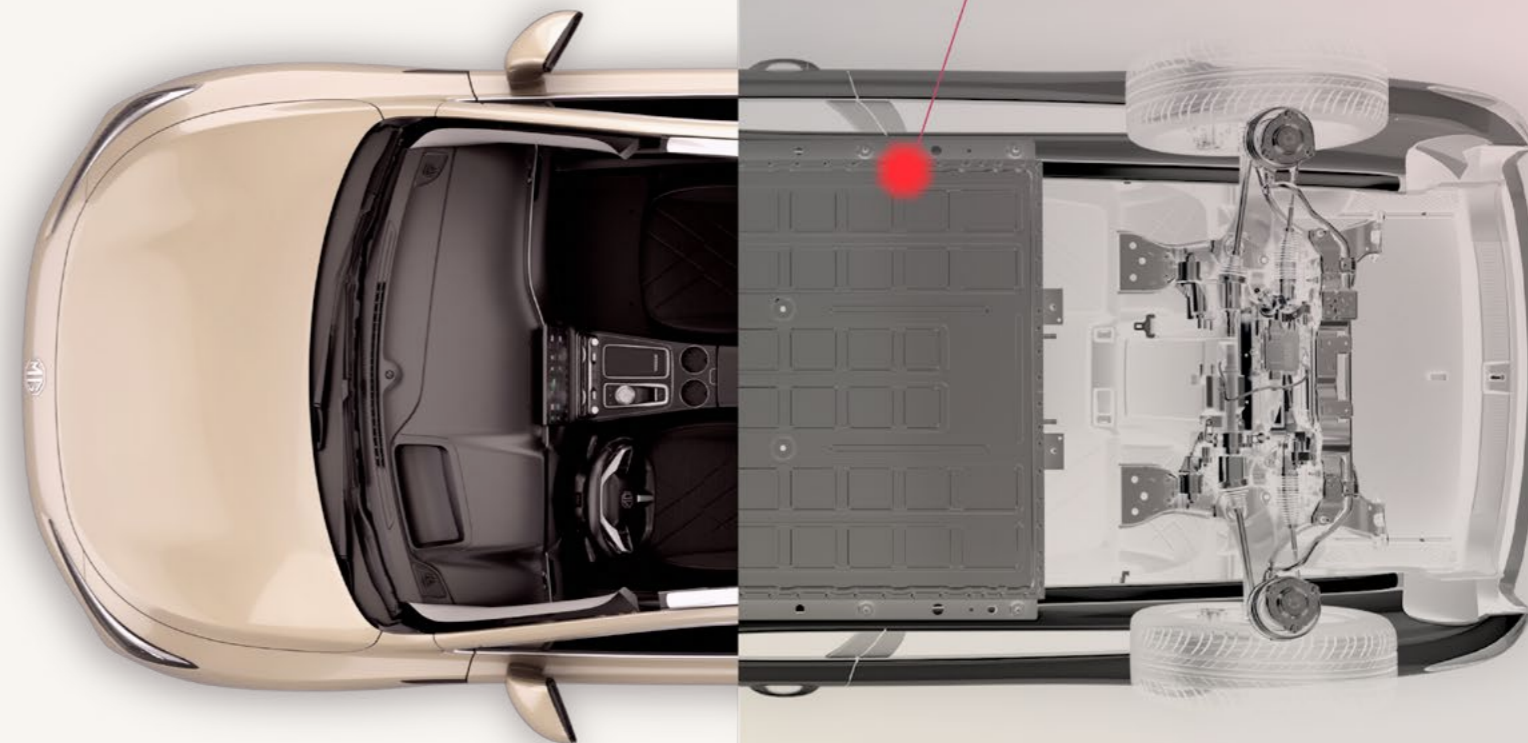

530KM RANGE (WLTP)

The Modular Scalable Platform (MSP), our purpose-built electric architecture, pairs seamlessly with an ultra-thin 77kWh NCM battery to unlock up to 530km of effortless WLTP combined range.

#### FAST CHARGING

With DC fast charging, you can charge the 77kWh battery from 10-80% in up to 38 minutes.

The MGS6 EV uses a 437V system meaning you can fast charge in speeds up to 144kW.

# COMPLETE

## SMART ALL-WHEEL DRIVE

Highly efficient motors power rear-wheel drive and all-wheel drive options to give you the perfect balance of dynamic yet composed control.

Select from five drive modes – Normal, Sport, Eco, Snow, or Custom – each attuned to your rhythm and the road ahead.

# CONTROL

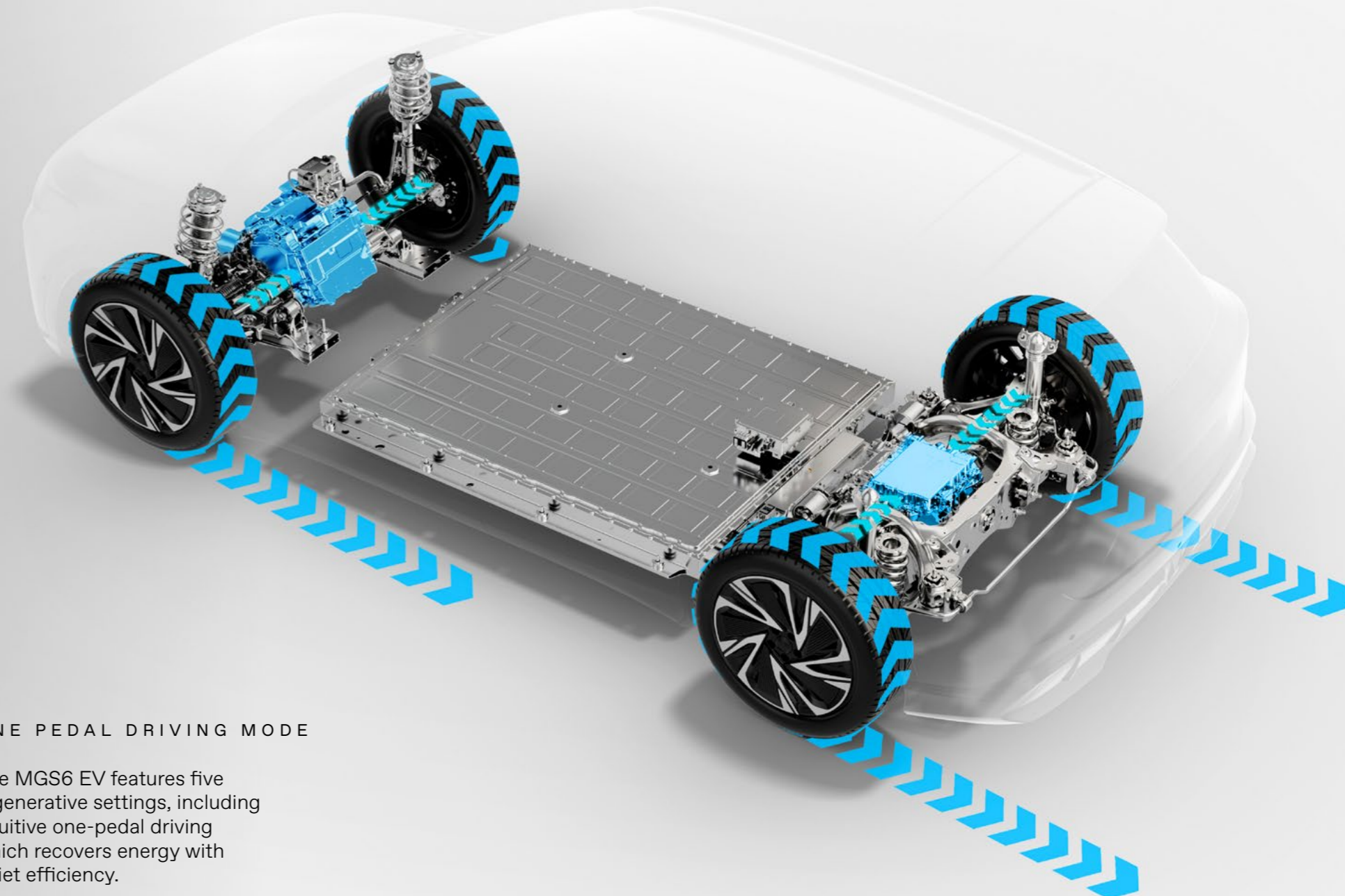

## ONE PEDAL DRIVING MODE

The MGS6 EV features five regenerative settings, including intuitive one-pedal driving which recovers energy with quiet efficiency.



ADVANCED

## INTUITIVE TECHNOLOGY

Technology that's  
perfectly attuned to you.

- HEAD UP DISPLAY
- 12.8" HD SCREEN
- WIRELESS CONNECTIVITY





#### HEAD UP DISPLAY

The head up display (HUD) projects essentials where your focus remains and is configurable to your preference.

#### 12.8 INCH HD TOUCHSCREEN

Designed to be highly intuitive, with simple functionality, the twin screen layout features a crystal clear 12.8-inch HD touchscreen and a 10.25-inch driver display which work in harmony. Physical buttons control the main functions making it tactile, easy and safe to operate on the move.

#### WIRELESS CONNECTION

The MGS6 EV integrates apps seamlessly so Spotify, Amazon Music, YouTube, and TikTok are ready to entertain. Wireless charging and wireless connectivity for Apple CarPlay™ and Android Auto™ also come as standard across the range.

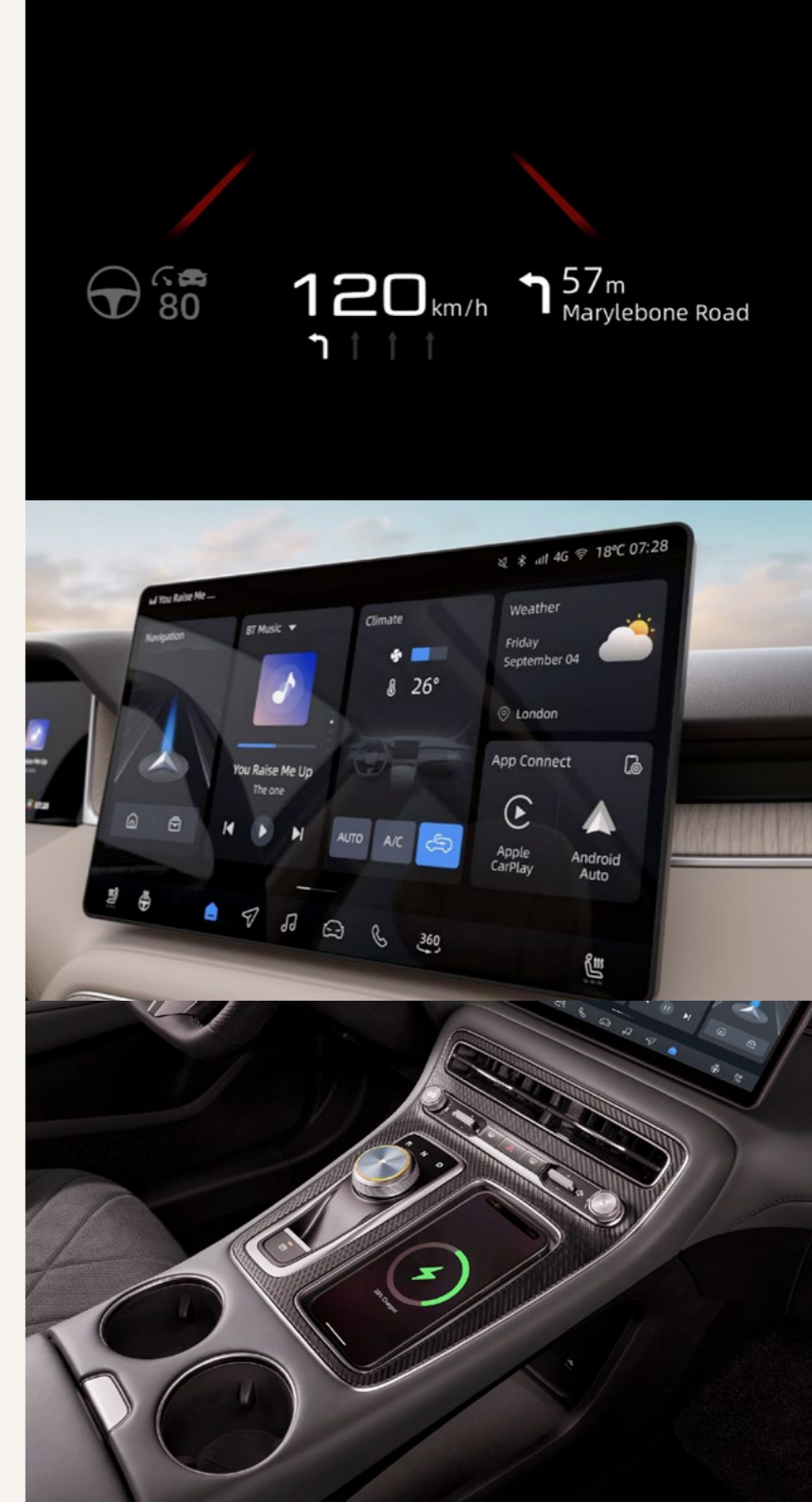

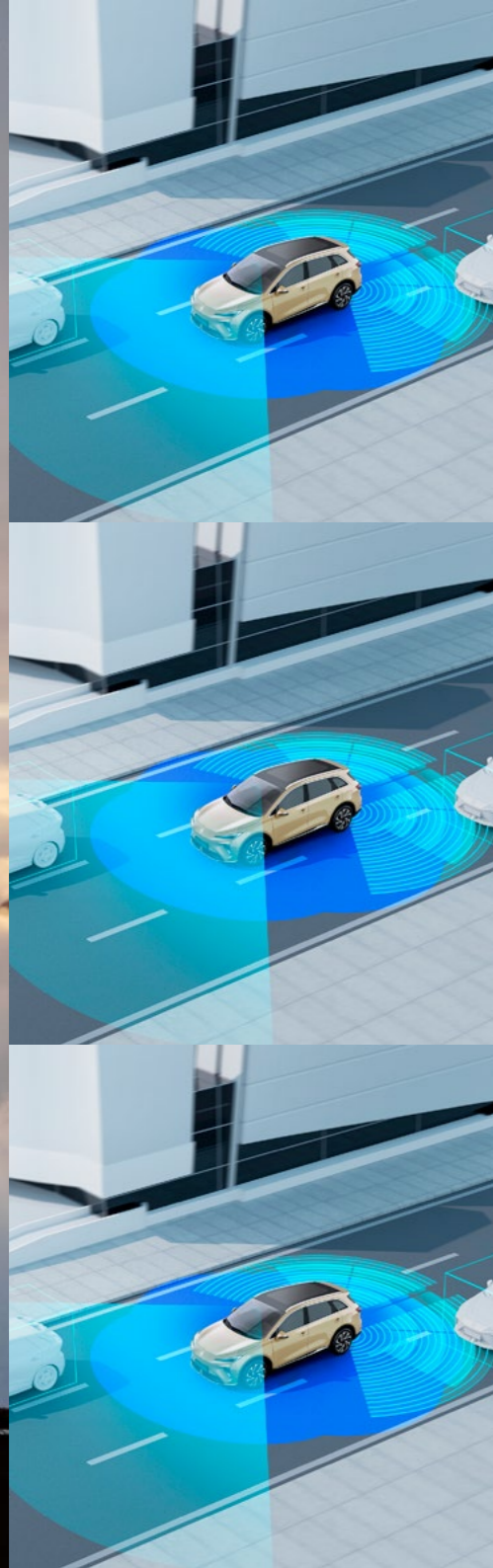

SAFETY

QUIET  
PROTECTION

Safety that preserves  
your peace of mind.

- MG PILOT CUSTOM
- HIGH PERFORMANCE BRAKES
- HIGH STRENGTH STEEL



ADVANCED  
HIGH-STRENGTH  
STEEL (AHSS)

HIGH-STRENGTH  
STEEL (HSS)

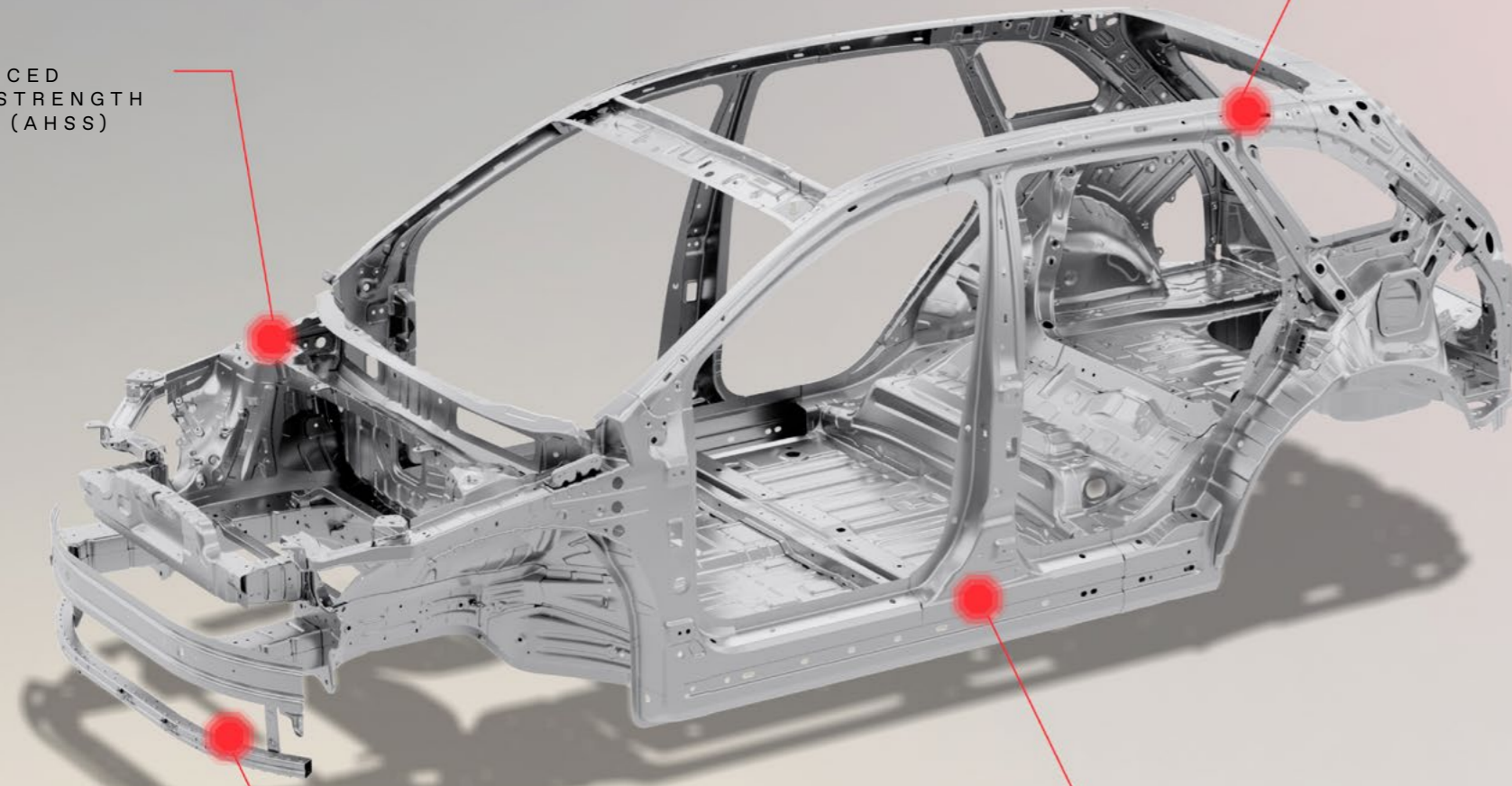

HOT-STAMPED STEEL

ULTRA HIGH-STRENGTH  
STEEL (UHSS)

#### MG PILOT CUSTOM

MG Pilot works in harmony with an advanced suite of driver assistance systems to thoughtfully anticipate what lies beyond your sightline. The MG Pilot Custom function allows you to personalise your preferred settings and recall them easily with each drive.

Active Emergency Braking, Lane Departure Warning, Adaptive Cruise Control, and Blind Spot Detection all monitor vigilantly with your safety in mind, allowing you to focus entirely on enjoying the journey ahead.

#### HIGH PERFORMANCE BRAKING

The MGS6 EV delivers a high-performance stopping power through an advanced braking system developed by Continental. The upgraded system on our Luxury Long Range model is capable of braking from 100km/h-0 in 36-metres.

#### COCOONED IN SAFETY

Awarded a 5-star NCAP rating, protection in the MGS6 EV works silently around you as a high-strength chassis creates a reassuring cocoon of safety. All models include seven airbags: front, side, curtain, and a central airbag, providing comprehensive passive safety for all occupants.

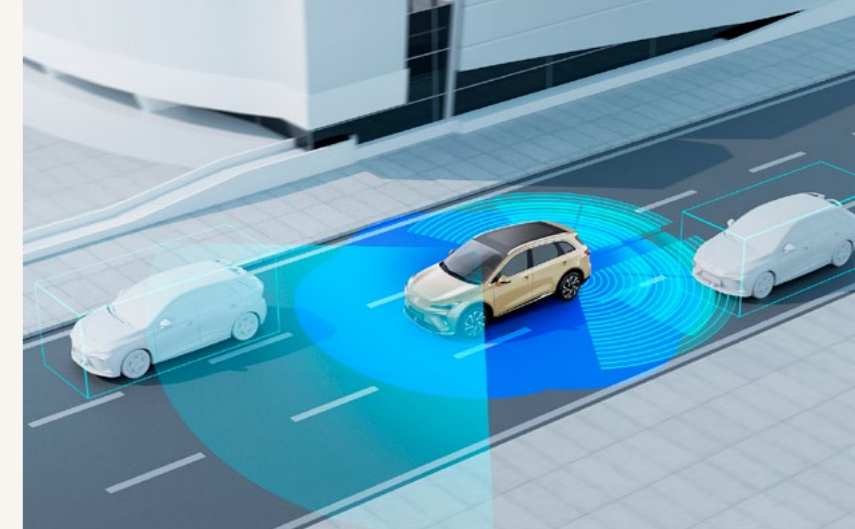



SPECIFICATIONS

PERSONALISE  
YOUR STYLE

- MGS6 EV LUXURY LONG RANGE
- MGS6 EV LUXURY DUAL MOTOR



# COLOUR OPTIONS



○ DOVER WHITE  
STANDARD PAINT



● PEBBLE BLACK  
METALLIC PAINT



● CAMDEN GREY  
METALLIC PAINT



● PICCADILLY BLUE  
METALLIC PAINT



● COSMIC SILVER  
METALLIC PAINT



● STRATFORD GOLD  
TRI-COAT PAINT



● DIAMOND RED  
TRI-COAT PAINT

# M G S 6 E V L U X U R Y L O N G R A N G E

- 20" Gulfstream Style Alloy Wheels with Aero Covers
- Panoramic Glass Roof with Electric Blind
- Grey Leather Style and Suede Style Seats with Carbon Effect Trim
- Ventilated Front Seats & Heated Rear Seats
- Driver 6-way & Passenger 4-Way Electric Seats
- Auto Dimming Rear View Mirror
- Head Up Display
- 360° Camera
- Hands-free Power Tailgate
- Ambient Lighting
- 11-Speaker Audio System
- Wireless Mobile Phone Charger
- Heat Pump



# MGS6 EV LUXURY DUAL MOTOR

- 119kW Front Motor
- All Wheel Drive
- 540 NM (+190 NM compared to Luxury Long Range)
- 20" Gulfstream Style Alloy Wheels with Aero Covers
- Panoramic Glass Roof with Electric Blind
- Grey Leather Style and Suede Style Seats with Carbon Effect Trim
- Ventilated Front Seats & Heated Rear Seats
- Driver 6-way & Passenger 4-Way Electric Seats
- Auto Dimming Rear View Mirror
- Head Up Display
- 360° Camera
- Hands-free Power Tailgate
- Ambient Lighting
- 11-Speaker Audio System
- Wireless Mobile Phone Charger
- Heat Pump

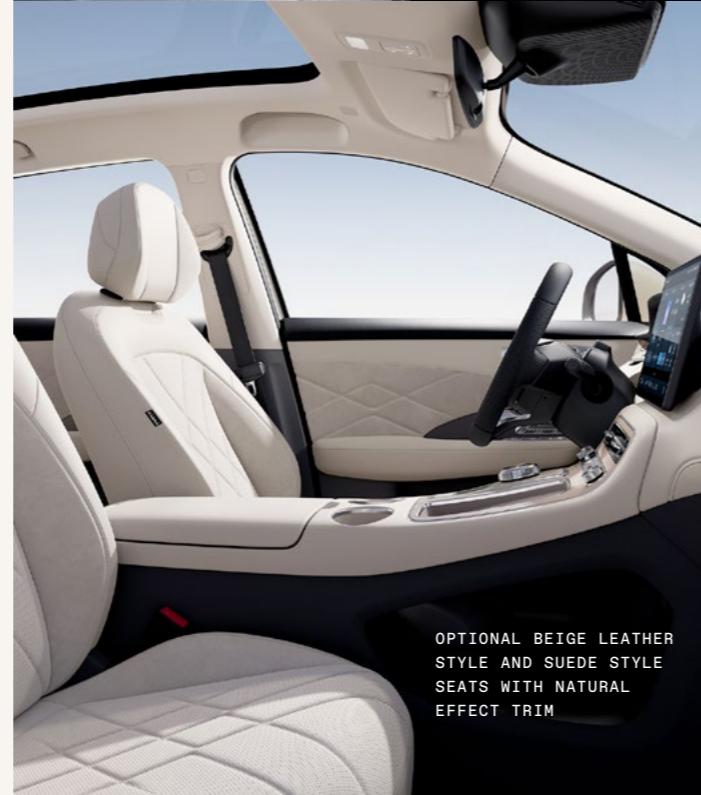

# FEATURES

MG Pilot	Luxury Long Range 77kWh	Luxury Dual Motor 77kWh
MG Pilot Custom Function	•	•
Adaptive Cruise Control (ACC) with Intelligent Cruise Assist (ICA)	•	•
Active Emergency Braking with Pedestrian and Bicycle Detection	•	•
Lane Keep Assist (LKA) with Lane Departure Warning System (LDWS)	•	•
Traffic Jam Assist (TJA)	•	•
Intelligent Speed Limit Assist with Traffic Sign Recognition	•	•
Intelligent High Beam Assist	•	•
Driver Monitoring System (DMS)	•	•
Blind Spot Detection (BSD)	•	•
Lane Change Assist (LCA)	•	•
Active Rear Cross Traffic Alert (RCTA + RCTB)	•	•
Door Opening Warning (DOW)	•	•

Safety & Security	Luxury Long Range 77kWh	Luxury Dual Motor 77kWh
ABS and EBD	•	•
ESP and EBA	•	•
Rear ISOFIX (x2)	•	•
Front Dual Airbags	•	•
Front Side Airbags	•	•
Front Central Airbag	•	•
Side Curtain Airbags	•	•
Front Passenger Airbag Deactivation Switch	•	•
Tyre Pressure Monitoring System (TPMS)	•	•
Electronic Parking Brake	•	•
Autohold Function	•	•
Hill Start Assist & Hill Descent Control	•	•
Driver's Seat Belt Reminder	•	•
Front and Rear Passenger's Seat Belt Reminder	•	•
Front and Rear Seat Belt (3 point with Pretensioner and Load Limiter)	•	•
Alarm & Immobiliser	•	•

Vehicle Exterior	Luxury Long Range 77kWh	Luxury Dual Motor 77kWh
Full Auto LED Headlights with Auto Low/High Beam with follow me home function	•	•
Integrated LED Daytime Running Lights	•	•
LED Rear Lights	•	•
Rear Fog Lights	•	•
LED Centre Brake Light	•	•
Rear Privacy Glass	•	•
Silver Roof Rails	•	•
Rear Spoiler	•	•
Front & Rear Parking Sensors	•	•
Active Grille System (AGS)	•	•
Electrically Adjustable, Power Folding, Heated, Door Mirrors with Tilt Down Memory Function	•	•

Wheels	Luxury Long Range 77kWh	Luxury Dual Motor 77kWh
20" Gulfstream Style Alloy Wheels with Aero Covers	•	•
Tyre Repair Kit	•	•

Seating	Luxury Long Range 77kWh	Luxury Dual Motor 77kWh
Grey Leather Style & Suede Style Seats with Carbon Effect Trim	•	•
Beige Leather Style & Suede Style Seats with Carbon Effect Trim	Optional	Optional
Electric Driver's 6-way Adjustable Seat with 4-Way Electric Lumbar Support and Memory Function	•	•
Electronic Passenger's 4-way Adjustable Seat	•	•
Map Pocket	•	•
2nd Row 60:40 Split Fold Seat	•	•
2nd 2 Level Adjustable Reclining 2nd Row Rear Seats	•	•
Rear Centre Armrest	•	•

Comfort & Convenience	Luxury Long Range 77kWh	Luxury Dual Motor 77kWh
Automatic Dual Zone Climate Control with Rear Vents	•	•
Heat Pump	•	•
Rain Sensing Wipers	•	•
Auto Dimming Rear View Mirror	•	•
Vehicle to Load charging	•	•
Battery pre-heating ahead of charging	•	•
Leather Style Multifunction Steering Wheel	•	•
Reach & Height Adjust Steering Wheel	•	•
Heated Steering Wheel	•	•
Heated (3 Levels) & Ventilated Front Seats (1 Level)	•	•
Heated Outer Rear Seats (1 Level)	•	•
Panoramic Glass Roof with Electric Blind	•	•
Hands Free Power Tailgate	•	•
5 Driving Modes (Normal, Sport, Eco, Snow, Custom)	•	•
4 Regenerative Braking Modes (Low (1), Medium (2), Strong (3), Adaptive (A))	•	•
One Pedal Driving	•	•
Keyless Entry	•	•
Ambient Lighting	•	•
Front & Rear Reading Lights	•	•
Front Sun Visors with Driver and Passenger Mirrors & Vanity Lights	•	•
Front & Rear Electric Windows with one-touch up/down	•	•

In-Car Entertainment	Luxury Long Range 77kWh	Luxury Dual Motor 77kWh
11-Speaker Audio System	•	•
DAB+ Radio	•	•
10.25" HD Full Digital Driver Information Display	•	•
12.8" HD Infotainment Screen	•	•
Head Up Display	•	•
iSMART	•	•
Satellite Navigation	•	•
Live Services (additional services include Weather, Live Traffic, YouTube, Spotify, TikTok, Amazon Music)	•	•
EV Trip Planner	•	•
Front 12V Socket	•	•
USB Ports (2 front - Type Cs / 2 rear - Type Cs)	•	•
Wireless Connection to Apple CarPlay™ and Android Auto™	•	•
50W Ventilated Wireless Mobile Phone Charger	•	•
360° Parking Camera with Transparent Chassis	•	•

Warranty & Servicing	
Service Intervals	1 year / 24,000km
Manufacturer's Warranty	7 years / 150,000km

# TECHNICAL DATA

Performance & Transmission		Luxury Long Range 77kWh	Luxury Dual Motor 77kWh
Transmission		Fixedratio	Fixedratio
Driven Wheels		Rear wheel drive, motor at rear	All wheel drive, motor at front & rear
Electric Motor Type		Synchronous Motor	Synchronous Motor
Suspension Set Up		Front MacPherson independent & Multi-link rear suspension	Front MacPherson independent & Multi-link rear suspension
Disc Brakes - Front		321mm	345mm
Disc Brakes		340mm	340mm
Battery Type		NCM (Nickel Cobalt Manganese)	NCM (Nickel Cobalt Manganese)
Battery Capacity (nominal)	kWh	77 kWh	77 kWh
Battery Capacity (usable)	kWh	74.3 kWh	74.3 kWh
Maximum Operating Voltage	V	437	437
Nominal Voltage	V	395	395
Maximum Power	PS (kw)	244 (180)	361 (266)
Maximum Torque	lb ft (NM)	258 (350)	398 (540)
0-100 km/h	seconds	7.3	5.1
Maximum Speed	km/h	200	200
Charger Connection Type		Combined Type 2 and CCS	Combined Type 2 and CCS
On-board Charger		AC	11kW
Maximum Rapid Charge Capability		DC	144kW
Estimated Charging Time (2.2kW AC 3-Pin Domestic)		10 to 100% (emergency use)	37 hours
Estimated Charging Time (7kW AC fast charger)		10 to 100%	8.5 hours
Estimated Charging Time (50kW DC public rapid charger)		10 to 80%	70 minutes
Estimated Charging Time (150kW DC public rapid charger)		10 to 80%	38 minutes
Electric Driving Efficiency - kWh/100km		Combined	16.6kWh/100km
		City	12.6kWh/100km
Maximum Driving Range - Kilometers		Combined	530
		City	700
CO2 - WLTP Combined		g/km	0

# DIMENSIONS

Dimensions	Luxury Long Range 77kWh	Luxury Dual Motor 77kWh
Overall Length (mm)	4,708 mm	
Width – Excluding Mirrors (mm)	1,912 mm	
Overall Width – Including Mirrors (mm)	2,142 mm	
Height – Including Roof Rails (mm)	1,672 mm	
Wheelbase (mm)	2,835 mm	
Front Track (mm)	1,622 mm	
Rear Track (mm)	1,612 mm	
Front Boot Capacity	124 litres	102 litres
Luggage capacity – Seats Up (l)	674 litres	
Luggage capacity – Seats Folded (l)	1,910 litres	
Tyre Size	235/55 R19	245/50 R20

Weight		Luxury Long Range 77kWh	Luxury Dual Motor 77kWh
Kerb Weight	kg	1,908	2,005
Gross Vehicle Weight	kg	2,388	2,465
Maximum Towing Weight (unbraked)	kg	750	750
Maximum Towing Weight (braked)	kg	1,500	1,500
Gross Train Weight	kg	3,888	3,965
Maximum Nose Ball Weight	kg	60	60
Maximum Roof Load	kg	75	75
Turning Circle	m	11.1	12.4



FRONT TRACK  
1,662MM



REAR TRACK  
1,612MM

HEIGHT  
1,672MM

WIDTH  
(INC MIRRORS)  
2,142MM

WIDTH  
(EXC MIRRORS)  
1,912MM

674 LITRE BOOT CAPACITY  
(SEATS UP)



WHEELBASE  
2,835MM

LENGTH  
4,708MM

1910 LITRE BOOT CAPACITY  
(SEATS FOLDED)

# AFTERCARE

## 7 YEAR WARRANTY

More peace of mind comes as standard with every MG. The MGS6 EV offers reassurance of our full 7 year or 150,000km warranty, whichever comes first.

What's more, your battery is covered by an 7 year warranty. Our warranties ensures that expert MG technicians will always be able to keep your car in the best of health. They're also fully transferable to future owners.

## MG SERVICE PLANS

To enjoy mile after mile of hassle-free motoring, you can avoid the worry of unexpected costs with an MG Service Plan. Your MG will be protected for up to seven years with a mileage range of your choice. And it will have the care and attention of the MG authorised repairer network, offering genuine parts and factory trained staff.





**7** YEAR  
WARRANTY

[mgmotor.eu](https://www.mgmotor.eu)

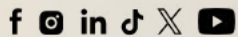

Terms and Conditions: Every effort has been made to ensure that the contents of this publication were accurate and up to date at the time of being published (November 2025). Please note colours and accessories are for illustrative purposes only. Colours and finishes replicated are subject to limitations of the printing process and may vary from actual colour and paint finish. MG Motor Europe endorses a policy of continuous improvement and reserves the right to make changes at any time without notice to colours, accessories, material, design, shape, specification and models. Items may be discontinued at any time. Actual EU specifications may vary from the vehicles shown. For latest information, please speak to your MG dealer.